**Soft soldering fluxes — Test
methods —**

Part 15:
Copper corrosion test

*Flux de brasage tendre — Méthodes d'essai —
Partie 15: Essai de corrosion du cuivre*

STANDARDSISO.COM : Click to view the full PDF of ISO 9455-15:2017



STANDARDSISO.COM : Click to view the full PDF of ISO 9455-15:2017



COPYRIGHT PROTECTED DOCUMENT

© ISO 2017, Published in Switzerland

All rights reserved. Unless otherwise specified, no part of this publication may be reproduced or utilized otherwise in any form or by any means, electronic or mechanical, including photocopying, or posting on the internet or an intranet, without prior written permission. Permission can be requested from either ISO at the address below or ISO's member body in the country of the requester.

ISO copyright office
Ch. de Blandonnet 8 • CP 401
CH-1214 Vernier, Geneva, Switzerland
Tel. +41 22 749 01 11
Fax +41 22 749 09 47
copyright@iso.org
www.iso.org

Contents

	Page
Foreword	iv
1 Scope	1
2 Normative references	1
3 Terms and definitions	1
4 Principle	1
5 Reagents and materials	1
6 Apparatus	2
7 Preparation of tests pieces	2
8 Procedure	3
8.1 General	3
8.2 Fluxing the test pieces	4
8.2.1 For solid, paste and liquid flux samples	4
8.2.2 For flux-cored solder samples	4
8.2.3 For solder paste samples	4
8.3 Heating the test pieces	4
8.4 Conditioning the test pieces	5
8.5 Examination of the test pieces	5
8.6 Assessment of corrosion	5
8.6.1 General	5
8.6.2 Examination after fluxing and melting	6
8.6.3 Examination after conditioning	6
9 Expression of results	6
10 Test report	6
Annex A (informative) Examples of varying degrees of corrosion resulting from the copper corrosion test	7
Bibliography	12

Foreword

ISO (the International Organization for Standardization) is a worldwide federation of national standards bodies (ISO member bodies). The work of preparing International Standards is normally carried out through ISO technical committees. Each member body interested in a subject for which a technical committee has been established has the right to be represented on that committee. International organizations, governmental and non-governmental, in liaison with ISO, also take part in the work. ISO collaborates closely with the International Electrotechnical Commission (IEC) on all matters of electrotechnical standardization.

The procedures used to develop this document and those intended for its further maintenance are described in the ISO/IEC Directives, Part 1. In particular the different approval criteria needed for the different types of ISO documents should be noted. This document was drafted in accordance with the editorial rules of the ISO/IEC Directives, Part 2 (see www.iso.org/directives).

Attention is drawn to the possibility that some of the elements of this document may be the subject of patent rights. ISO shall not be held responsible for identifying any or all such patent rights. Details of any patent rights identified during the development of the document will be in the Introduction and/or on the ISO list of patent declarations received (see www.iso.org/patents).

Any trade name used in this document is information given for the convenience of users and does not constitute an endorsement.

For an explanation on the voluntary nature of standards, the meaning of ISO specific terms and expressions related to conformity assessment, as well as information about ISO's adherence to the World Trade Organization (WTO) principles in the Technical Barriers to Trade (TBT) see the following URL: www.iso.org/iso/foreword.html.

This document was prepared by Technical Committee ISO/TC 44, *Welding and allied processes*, Subcommittee SC 12, *Soldering materials*.

This second edition cancels and replaces the first edition (ISO 9455-15:1996), which has been technically revised.

The main changes compared to the previous edition are as follows:

- the use of lead-free solders has been included;
- the requirements for the apparatus have been updated;
- the test report has been updated;
- the figures in [Annex A](#) have been re-arranged;
- this document has been editorially revised.

A list of all parts in the ISO 9455 series can be found on the ISO website.

Requests for official interpretations of any aspect of this document should be directed to the Secretariat of ISO/TC 44/SC 12 via your national standards body. A complete listing of these bodies can be found at www.iso.org.

Soft soldering fluxes — Test methods —

Part 15: Copper corrosion test

1 Scope

This document specifies a qualitative method for determination of the corrosive properties of flux residues on a copper substrate when subjected to controlled environmental conditions. The test is applicable to type 1 fluxes, as defined in ISO 9454-1.

2 Normative references

The following documents are referred to in the text in such a way that some or all of their content constitutes requirements of this document. For dated references, only the edition cited applies. For undated references, the latest edition of the referenced document (including any amendments) applies.

ISO 197-1, *Copper and copper alloys — Terms and definitions — Part 1: Materials*

ISO 9453, *Soft solder alloys — Chemical compositions and forms*

ISO 9455-1, *Soft soldering fluxes — Test methods — Part 1: Determination of non-volatile matter, gravimetric method*

ISO 9455-2, *Soft soldering fluxes — Test methods — Part 2: Determination of non-volatile matter, ebulliometric method*

IEC 60068-2-78, *Environmental testing — Part 2-78: Tests — Test Cab: Damp heat, steady state*

3 Terms and definitions

No terms and definitions are listed in this document.

ISO and IEC maintain terminological databases for use in standardization at the following addresses:

- IEC Electropedia: available at <http://www.electropedia.org/>
- ISO Online browsing platform: available at <http://www.iso.org/obp>

4 Principle

A pellet of solder is melted in contact with the flux to be tested on a test piece of copper sheet. The test piece is then exposed to a controlled temperature/humidity environment and the resulting corrosion of the copper, if any, is assessed using a low-power microscope.

5 Reagents and materials

Only reagents of recognized analytical quality and only distilled or deionized water shall be used.

5.1 Ammonium peroxodisulfate solution, prepared as follows.

Dissolve 250 g of ammonium peroxodisulfate $[(\text{NH}_4)_2\text{S}_2\text{O}_8]$ in water and add cautiously 5 ml of sulfuric acid (density 1,84 g/ml). Mix, cool, dilute to 1 l and mix. This solution shall be freshly prepared before use.

5.2 Sulfuric acid, 5 % (by volume) solution.

Add cautiously, with stirring, 50 ml of sulfuric acid ($\rho = 1,84 \text{ g/ml}$) to 400 ml of water and mix. Cool, dilute to 1 l and mix well.

5.3 Degreasing solvent, such as acetone or petroleum ether.

5.4 0,5 mm thick copper sheet, phosphorus deoxidized, complying with ISO 197-1.

5.5 Solder wire or pellets, complying with ISO 9453, Sn63Pb37, Sn60Pb40, Sn96,5Ag3Cu0,5 or any other solder alloy as agreed between the user and the supplier.

6 Apparatus

Usual laboratory apparatus and, in particular, the following.

6.1 Solder bath

Heat solder pot so that solder bath stabilizes at $(235 \pm 5) \text{ }^\circ\text{C}$ in the case of Sn63Pb37 and Sn60Pb40 alloy, or at $(255 \pm 3) \text{ }^\circ\text{C}$ for Sn96,5Ag3Cu0,5, or at $(35 \pm 3) \text{ }^\circ\text{C}$ higher than the liquidus temperature of any other solder alloy as agreed between the user and the supplier. For solder alloys except Sn63Pb37 and Sn60Pb40, the temperature of the solder pot may be approximately 40 °C higher than the liquid temperature of each alloy.

6.2 Humidity chamber, conforming to the temperature and humidity requirements of IEC 60068-2-78, test Cab.

6.3 Cupping device (e.g. an Erichsen cupping machine or equivalent cupping device).

The device shall be fitted with a 27 mm diameter die and a 20 mm diameter steel ball (see [Figure 1](#)).

6.4 Drying oven (air circulating), suitable for use at $(60 \pm 2) \text{ }^\circ\text{C}$.

6.5 Low-power stereomicroscope, capable of $\times 20$ magnification, equipped with quartz-halogen illumination.

6.6 Tongs or other suitable mechanical device, to lift the test piece from the surface of the molten solder bath.

7 Preparation of test pieces

From a sheet of copper 0,5 mm thick ([5.4](#)), cut square test pieces 50 mm \times 50 mm each.

Clamp each of the test pieces, in turn, centrally onto the 27 mm diameter die of the cupping device ([6.3](#)). Using the 20 mm diameter steel ball, make a 3 mm deep depression in the centre of each test piece by forcing the ball into the die (see [Figure 1](#)). One corner of the test piece may be bent up to facilitate handling with the tongs ([6.6](#)).

Immediately before use, pretreat the test pieces in accordance with the following sequence of operations a) to h), ensuring that clean tongs (6.6) are used for handling.

- a) Degrease the test pieces with a suitable neutral organic solvent (5.3).
- b) Immerse the test pieces in sulfuric acid solution (5.2) at $(65 \pm 5) ^\circ\text{C}$ for 1 min to remove the tarnish film.
- c) Immerse the test pieces in the ammonium peroxodisulfate solution (5.1) at $20 ^\circ\text{C}$ to $25 ^\circ\text{C}$ for 1 min to etch the surface uniformly.
- d) Wash the test pieces under running tap water for a maximum of 5 s.
- e) Immerse the test pieces in sulfuric acid solution (5.2) at a temperature not greater than $25 ^\circ\text{C}$ for 1 min.
- f) Wash the test pieces under running water for about 5 s and rinse in distilled or deionized water. Immerse immediately in the degreasing solvent (5.3).
- g) Allow the test pieces to dry in clean air.
- h) Use the test pieces immediately or after a maximum storage period of up to 60 min in a closed container.

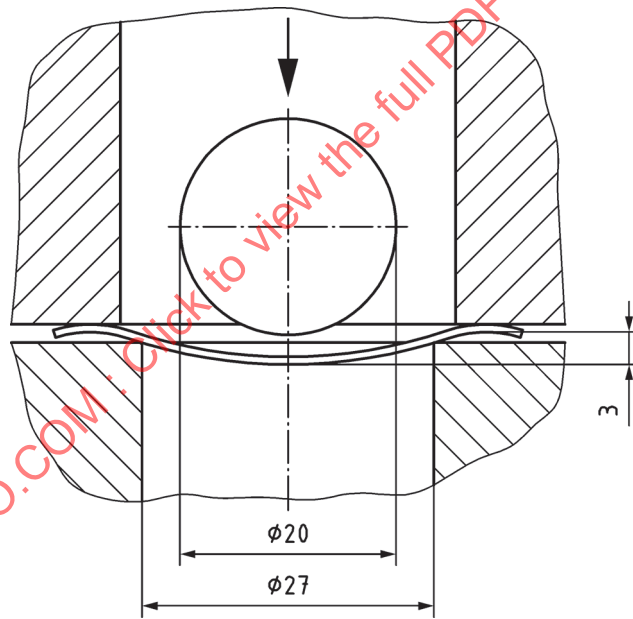

Figure 1 — Dimensions of penetrator, die and blank-holder

8 Procedure

8.1 General

Select three cleaned copper test pieces (see Clause 7), one of which will serve as the blank. Follow the procedures in 8.2 to 8.6 on the three test pieces. Omit the procedures in 8.4 in the case of the blank.

8.2 Fluxing the test pieces

8.2.1 For solid, paste and liquid flux samples

Weigh $(1,00 \pm 0,05)$ g of the solder wire or pellets (5.5), previously degreased with a neutral organic solvent (5.3), and transfer to the centre of the depression in one of the test pieces (see 8.1).

NOTE This may conveniently be done, if wire is used, by forming the wire into a small flat coil.

Repeat for the other two test pieces (see 8.1).

According to the form of the flux under test, continue with the preparation of the test pieces by following the procedure given in either a) or b) as follows.

- a) If the flux under test is in solid or paste form, weigh between 0,035 g and 0,040 g of the solid or paste flux and add this to the solder in the depression of the test piece. Repeat for the other two test pieces.
- b) If the flux under test is in liquid form, first determine its non-volatile matter content by the use of the method described in ISO 9455-1 or ISO 9455-2, then add the appropriate volume of the liquid flux, to contain between 0,035 g and 0,040 g of non-volatile matter, to the solder in the depression of the test piece. If the non-volatile matter content of the liquid flux is so low that the volume required would more than fill the depression, then use sufficient flux to just fill the depression. Repeat for the other two test pieces.

Evaporate the solvent at (60 ± 2) °C for 10 min in the drying oven (6.4).

8.2.2 For flux-cored solder samples

If the flux is present in the form of flux-cored solder, degrease the surface of a suitable length of the cored solder sample, using a cloth dampened with the solvent (5.3). Weigh $(1,00 \pm 0,05)$ g of the degreased sample, form it into a small flat coil and place it in the centre of the depression in one of the test pieces (see 8.1). Repeat for the other two test pieces.

8.2.3 For solder paste samples

If the flux is present in the form of solder paste, weigh $(0,50 \pm 0,05)$ g of the solder paste sample into the centre of the depression in one of the test pieces (see 8.1). Repeat for the other two test pieces.

8.3 Heating the test pieces

Using the tongs (6.6) or other suitable means, carefully lower the fluxed test piece from 8.2 onto the surface of the molten solder, maintained at the test temperature in the solder bath (6.1). Depending on the type of solder used for the test, the test temperature shall be selected from one of the following:

- Sn60Pb40 (see ISO 9453) at (235 ± 3) °C;
- Sn96,5Ag3Cu0.5 (see ISO 9453) at (255 ± 3) °C;
- any other solder as agreed between the customer and the flux supplier at (35 ± 3) °C higher than the liquidus temperature of any other solder alloy.

Allow the test piece to remain in contact until the solder melts and leave the test piece in this position for a further 5 s.

Maintaining the test piece in a horizontal position, remove it carefully from the heating bath and allow it to cool for 30 min.

Repeat for the other two test pieces.

Examine the specimens using the microscope (6.5) at $\times 20$ magnification and record their surface appearance for subsequent comparison after conditioning (see 8.4 and 8.6.2).

It is recommended that a photographic record be obtained to facilitate this comparison.

8.4 Conditioning the test pieces

Retaining one of the specimens from [8.3](#) as a blank, preheat the other two to 40 °C (see note) and then place them in a vertical position in the humidity chamber ([6.2](#)), operating at a temperature of (40 ± 2) °C and at a relative humidity of 90 % to 95 %.

NOTE Preheating the test pieces avoids condensation onto the test pieces when they are placed in the chamber, which, if it occurred, would invalidate the test.

Allow the two specimens to remain in the chamber, under these conditions of temperature and humidity, for 3 days.

8.5 Examination of the test pieces

Remove the test pieces from the humidity chamber. Examine for evidence of corrosion, using the microscope ([6.5](#)) at $\times 20$ magnification, and compare with the surface appearance of the pieces before conditioning (see [8.3](#)) and with the blank, assessing the corrosion in accordance with [8.6](#).

8.6 Assessment of corrosion

8.6.1 General

In this test, corrosion results from a progressive chemical reaction between the copper, the solder and the constituents in the flux residues. For a corrosive flux, the corrosion occurs after soldering and during exposure to the test conditions given in [8.4](#).

When corrosion occurs, growths of solid corrosion product resulting from the chemical reaction become visible

- a) at the boundaries of the flux residues on the copper,
- b) through discontinuities or cracks in the residues, and/or
- c) as spots under the residues.

NOTE 1 Examples illustrating corrosion of these types are given in [Annex A](#).

Each of the figures shown in [Annex A](#) illustrates a typical used test piece after conditioning, showing the silver/blue solder in the centre of the depression in the test piece and surrounded by the flux residue. Each of these is accompanied by a magnified view of a specific area of the test piece [two magnified views in the case of [Figure A.1 e](#)].

NOTE 2 The figures shown in [Annex A](#) are provided for guidance only.

[Figure A.1 a](#)) and [Figure A.1 b](#)) illustrate test pieces corresponding to typical results obtained from fluxes which PASS the test. [Figure A.1 c](#)) to [Figure A.1 e](#)) show increasing degrees of corrosion, and all correspond to fluxes which FAIL the test. The principal features of these figures are as follows.

- [Figure A.1 a](#)): The flux residue is of a brown to brownish-green translucent appearance. The residue is cracked, but there is no evidence at all of any growth of corrosion product. This flux PASSES the test.
- [Figure A.1 b](#)): The flux residue is translucent and in the magnified view, olive-green areas are evident in the flux residue due to dissolved copper salts. There is no evidence at all of any growth of corrosion product. This flux PASSES the test.
- [Figure A.1 c](#)): In the magnified area, the small blue spots at the flux/copper boundary are clear evidence of the growth of corrosion product. This flux FAILS the test.

- [Figure A.1 d\)](#): A considerable amount of blue corrosion growth in the darker areas of the residue, in both views illustrated, is evidence of severe corrosion. This flux FAILS the test.
- [Figure A.1 e\)](#): The magnified views reveal extensive blue spots of corrosion product growth under the flux residue and in cracks in the residue. This flux FAILS the test.

8.6.2 Examination after fluxing and melting

When the test pieces are examined after melting the solder, but before conditioning in the humidity chamber (see [8.3](#)), and show signs of blue spots as in [Figure A.1 c\)](#) or [Figure A.1 d\)](#), the flux shall be deemed to have failed the test, and further testing is unnecessary.

However, any change in the colour of the residue which may be observed at this stage of the test procedure, usually to a green hue, without the growth of solid corrosion products can be ignored.

8.6.3 Examination after conditioning

When the test pieces are examined after conditioning in the humidity chamber (see [8.4](#) and [8.5](#)) and appear comparable with the typical examples given in [Figure A.1 a\)](#) and [Figure A.1 b\)](#), the flux shall be deemed to have passed the test. However, if at this stage the test pieces reveal the evidence of corrosion comparable with the typical examples given in [Figure A.1 c\)](#), [Figure A.1 d\)](#) or [Figure A.1 e\)](#), the flux shall be deemed to have failed the test.

NOTE During conditioning in the humidity chamber, the flux residue and/or the copper test pieces may change in appearance without exhibiting corrosion. For example, the copper may become tarnished or the flux residue may become opaque. These effects, if they occur, can be ignored.

9 Expression of results

The results shall be assessed in accordance with the criteria given in [8.5](#) and [8.6](#) and recorded as PASS or FAIL.

10 Test report

The test report shall include at least the following information:

- a) the identification of the test sample;
- b) the test method used (a reference to this document, i.e. ISO 9455-15);
- c) results obtained;
- d) any unusual features noted during the test;
- e) details of any operation not included in this document, or regarded as optional;
- f) the date.

Annex A
(informative)

**Examples of varying degrees of corrosion resulting from the
copper corrosion test**

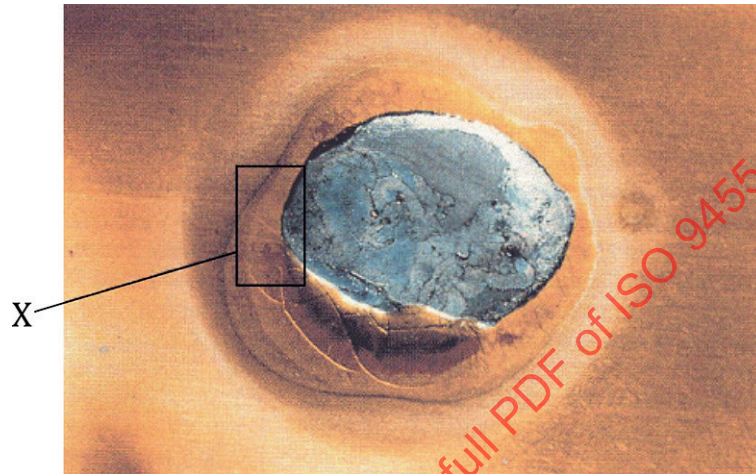

a) Brownish-green flux residue but no evidence of corrosion growth: PASS

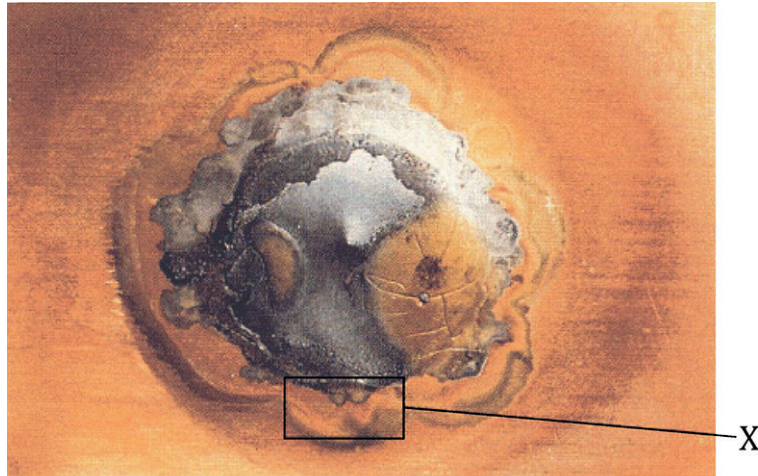

X

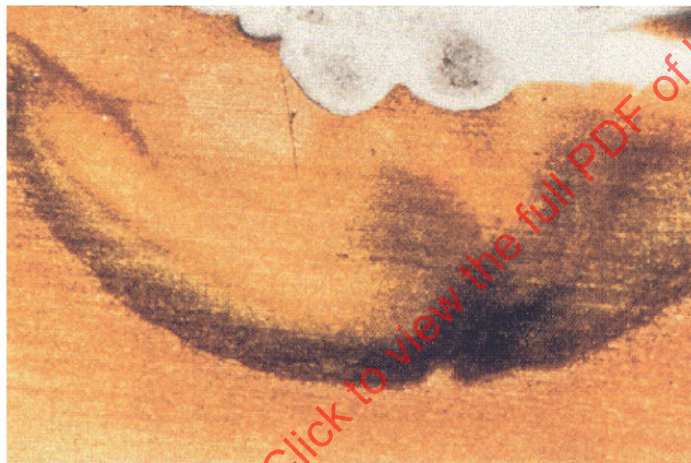

b) Olive-green flux residue due to copper salts, but no evidence of corrosion growth: PASS

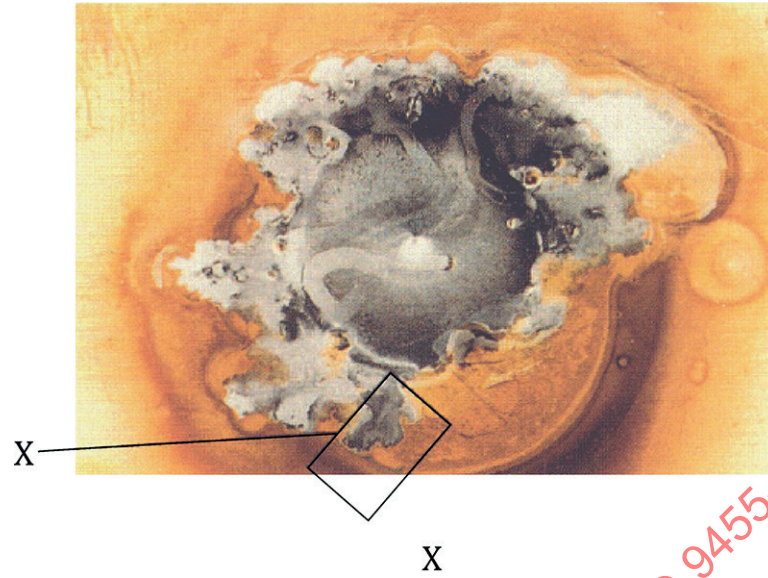

STANDARDSISO.COM : Click to view the full PDF of ISO 9455-15:2017

c) Corrosion product growth (blue spots) at the flux/copper boundary: FAIL

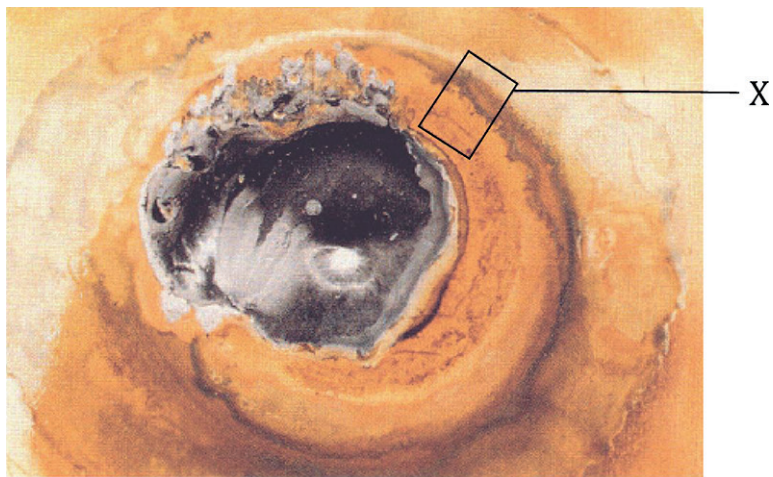

X

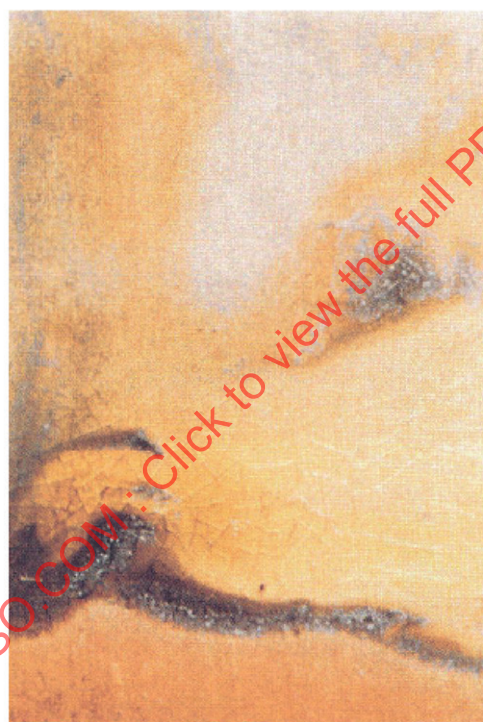

d) Severe corrosion in darker areas of the residue: FAIL